

## DS-2DE4215IW-DE(S6) 2 MP 15× Network IR Speed Dome



Hikvision DS-2DE4215IW-DE(S6) 2MP 15× Network IR Speed Dome adopts 1/2.8" progressive scan CMOS chip. With the 15× optical zoom lens, the camera offers more details over expansive areas. This series of cameras can be widely used for wide ranges of high-definition, such as the rivers, roads, railways, airports, squares, parks, scenic spots, and venues, etc.

- 1/2.8" progressive scan CMOS
- High quality imaging with 2 MP resolution
- Excellent low-light performance with powered-by-DarkFighter technology
- 15× optical zoom and 16× digital zoom provide close up views over expansive areas
- WDR, HLC, BLC, 3D DNR, defog, regional exposure, regional focus
- Expansive night view with up to 100 m IR distance
- Support H.265+/H.265 video compression



## ▪ DORI

The DORI (detect, observe, recognize, identify) distance gives the general idea of the camera ability to distinguish persons or objects within its field of view.

It is calculated based on the camera sensor specification and the criteria given by EN 62676-4: 2015.

DORI	Detect	Observe	Recognize	Identify
Definition	25 px/m	63 px/m	125 px/m	250 px/m
Distance (Tele)	960.0 m (3149.6 ft)	381.0 m (1249.8 ft)	192.0 m (629.9 ft)	96.0 m (315.0 ft)

## ▪ Specification

Camera Module	
Image Sensor	1/2.8" progressive scan CMOS
Min. Illumination	Color: 0.005Lux @ (F1.6, AGC ON), B/W: 0.001Lux @ (F1.6, AGC ON), 0 Lux with IR
Shutter Speed	1 s to 1/30,000 s
Slow Shutter	yes
Focus	semi-auto, manual, auto
Day & Night	ICR
Day/Night Switch	day, night, auto, scheduled-switch
BLC	yes
WDR	120 dB WDR
HLC	yes
3D DNR	yes
Defog	yes
Regional Exposure	yes
Regional Focus	yes
Image Settings	saturation, brightness, contrast, sharpness
Image Parameters Switch	yes
White Balance	auto, ATW, sodium lamp, fluorescent lamp, indoor, outdoor, MWB, Locked WB
Digital Zoom	16x
Optical Zoom	15x
Privacy Mask	up to 24 masks, mask color configurable
SNR	> 52dB
Lens	
Focal Length	5 mm to 75 mm, 15x Optical
Zoom Speed	Approx. 2.3 s
FOV	Horizontal field of view: 57.6° to 4° (wide-tele), Vertical field of view: 34.4° to 2.3° (wide-tele), Diagonal field of view: 64.5° to 4.6° (wide-tele)
Aperture	F1.6
PTZ	
Movement Range (Pan)	360°
Movement Range (Tilt)	-15° to 90° (auto flip)
Pan Speed	pan speed: configurable from 0.1° to 80°/s; preset speed: 80°/s
Tilt Speed	tilt speed: configurable from 0.1° to 80°/s, preset speed 80°/s
Proportional Zoom	yes

Presets	300
Patrol Scan	8 patrols, up to 32 presets for each patrol
Pattern Scan	4 pattern scans
Power-off Memory	yes
Park Action	preset, pattern scan, patrol scan, auto scan, tilt scan, random scan, frame scan, panorama scan
3D Positioning	yes
PTZ Status Display	yes
Preset Freezing	yes
Scheduled Task	preset, pattern scan, patrol scan, auto scan, tilt scan, random scan, frame scan, panorama scan, dome reboot, dome adjust, aux output
<b>Video</b>	
Max. Resolution	1920 × 1080
Stream Type	main stream, sub-stream, third stream
Main Stream	50 Hz: 25 fps (1920 × 1080, 1280 × 960, 1280 × 720) 60 Hz: 30 fps (1920 × 1080, 1280 × 960, 1280 × 720)
Sub-Stream	50 Hz: 25 fps (704 × 576, 640 × 480, 352 × 288) 60 Hz: 30 fps (704 × 480, 640 × 480, 352 × 240)
Third Stream	50 Hz: 25 fps (1920 × 1080, 1280 × 960, 1280 × 720, 704 × 576, 640 × 480, 352 × 288) 60 Hz: 30 fps (1920 × 1080, 1280 × 960, 1280 × 720, 704 × 480, 640 × 480, 352 × 240)
Video Compression	H.265, H.264, MJPEG
Video Bit Rate	32 kbps to 16384 kbps
H.264 Type	baseline profile, main profile, high profile
H.265 Type	main profile
H.264+	yes
H.265+	yes
SVC	yes
ROI	fixed region, main stream, sub-stream and third stream respectively support eight fixed areas
<b>Audio</b>	
Audio Compression	G.711alaw, G.711ulaw, G.722.1, G.726, MP2L2, PCM
Audio Bit rate	MP2L2: 32 kbps, 40 kbps, 48 kbps, 56 kbps, 64 kbps, 80 kbps, 96 kbps, 112 kbps, 128 kbps, 144 kbps, 160 kbps, 192 kbps
Audio Sampling Rate	MP2L2: 16 kHz, 32 kHz, 48 kHz, PCM: 8 kHz, 16 kHz, 32 kHz, 48 kHz
Environment Noise Filtering	yes
<b>Smart Features</b>	
Basic Event	motion detection, alarm input, alarm output, video tampering alarm, exception
Smart Event	face detection, intrusion detection, line crossing detection, region entrance detection, region exiting detection, unattended baggage detection, object removal detection, audio exception detection
Smart Record	ANR, Dual-VCA
Alarm Linkage	memory card video recording, alarm output, sending email, notify surveillance center, upload to FTP, NAS video recording
<b>Network</b>	
Network Storage	NAS (NFS, SMB/ CIFS)

Protocols	IPv4/IPv6, HTTP, HTTPS, 802.1x, Qos, FTP, SMTP, UPnP, SNMP, DNS, DDNS, NTP, RTSP, RTCP, RTP, TCP/IP, UDP, IGMP, ICMP, DHCP, PPPoE, Bonjour, ISUP, WebSocket, WebSockets
API	Open-ended API, ISAPI, Hikvision SDK, Third-party management platform, Hik-Connect, ISUP, Open Network Video Interface, CGI
Simultaneous Live View	20
User/Host	32
Security Measures	Authenticated username and password, MAC address binding, HTTPS encryption, 802.1X authenticated access, IP address filter
Client	iVMS-4200, Hik-Connect
Web Browser	IE10-11, Chrome 57+, Firefox 52+, Safari 12+
<b>Interface</b>	
Communication Interface	RJ45, self-adaptive 10M/100M Ethernet port
On-board Storage	support microSD/microSDHC/microSDXC cards, up to 256 GB
Alarm Input	1 alarm input
Alarm Output	1 alarm output
Audio Input	1 audio input, 2.0 to 2.4Vp-p, 1k Ohm±10%
Audio Output	1 audio output, line level, impedance: 600 Ω
<b>Supplement Light</b>	
IR Distance	100 m
<b>General</b>	
Power	12 VDC,PoE (802.3at)
Power Consumption and Current	Max. 18 W, including max. 1.6 W for heater and 9 W for IR
Operating Conditions	-30°C to 65°C (-22°F to 149°F), humidity lower than 90%RH
Reset	yes
Demist	yes
Material	ADC12
Dimensions	∅ 164.5 mm × 290 mm (∅ 6.48" × 11.42")
Weight	Approx. 2 kg (4.41 lb.)
<b>Approval</b>	
Protection	IP66 Standard, 6000V Lightning Protection, Surge Protection and Voltage Transient Protection

### ▪ Available Model

DS-2DE4215IW-DE(S6)(B)

### ▪ Typical Application

Hikvision products are classified into three levels according to their anti-corrosion performance. Refer to the following description to choose for your using environment.

This model has NO SPECIFIC PROTECTION.

Level	Description
Top-level protection	Hikvision products at this level are equipped for use in areas where professional anti-corrosion

	protection is a must. Typical application scenarios include coastlines, docks, chemical plants, and more.
Moderate protection	Hikvision products at this level are equipped for use in areas with moderate anti-corrosion demands. Typical application scenarios include coastal areas about 2 kilometers (1.24 miles) away from coastlines, as well as areas affected by acid rain.
No specific protection	Hikvision products at this level are equipped for use in areas where no specific anti-corrosion protection is needed.

▪ **Dimension**

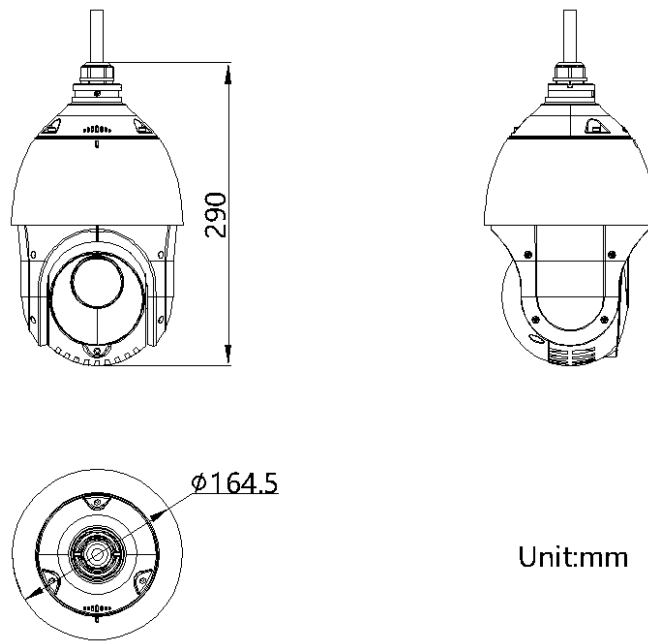



















▪ **Accessory**

▪ **Included**

DS-1618ZJ	ASW0081-122000 2W
	

▪Optional

<b>DS-1667ZJ</b>	<b>DS-1661ZJ</b>	<b>DS-1662ZJ</b>	<b>DS-1619ZJ</b>	<b>DS-1602ZJ</b>
				
<b>DS-1604ZJ-corner</b>	<b>DS-1005KI</b>	<b>DS-1604ZJ-BOX-CORNER</b>		<b>DS-1604ZJ-pole</b>
				
<b>DS-1681ZJ</b>	<b>DS-1100KI(B)</b>	<b>DS-1660ZJ</b>	<b>DS-1671ZJ-SDM9</b>	<b>DS-1663ZJ</b>
				
<b>DS-1604ZJ-BOX-POLE</b>	<b>DS-1604ZJ</b>	<b>DS-1682ZJ</b>	<b>DS-1604ZJ-box</b>	
				

\*DS-1673ZJ should be used with DS-1661ZJ or DS-1602ZJ.

Distributed by

**HIKVISION®****Headquarters**

No.555 Qianmo Road, Binjiang District,  
Hangzhou 310051, China  
T +86-571-8807-5998  
overseasbusiness@hikvision.com

**Hikvision USA**  
T +1-909-895-0400  
sales.usa@hikvision.com

**Hikvision Australia**  
T +61-2-8599-4233  
salesau@hikvision.com

**Hikvision India**  
T +91-22-28469900  
sales@pramahikvision.com

**Hikvision Canada**  
T +1-866-200-6690  
sales.canada@hikvision.com

**Hikvision Thailand**  
T +662-275-9949  
sales.thailand@hikvision.com

**Hikvision Europe**  
T +31-23-5542770  
sales.eu@hikvision.com

**Hikvision Italy**  
T +39-0438-6902  
info.it@hikvision.com

**Hikvision Brazil**  
T +55 11 3318-0050  
Latam.support@hikvision.com

**Hikvision Turkey**  
T +90 (216)521 7070- 7074  
sales.tr@hikvision.com

**Hikvision Malaysia**  
T +601-7652-2413  
sales.my@hikvision.com

**Hikvision UK & Ireland**  
T +01628-902140  
sales.uk@hikvision.com

**Hikvision South Africa**  
Tel: +27 (10) 0351172  
sale.africa@hikvision.com

**Hikvision France**  
T +33(0)1-85-330-450  
info.fr@hikvision.com

**Hikvision Kazakhstan**  
T +7-727-9730667  
nikia.panfilov@hikvision.ru

**Hikvision Vietnam**  
T +84-974270888  
sales.vt@hikvision.com

**Hikvision UAE**  
T +971-4-4432090  
salesme@hikvision.com

**Hikvision Singapore**  
T +65-6684-4718  
sg@hikvision.com

**Hikvision Spain**  
T +34-91-737-16-55  
info.es@hikvision.com

**Hikvision Tashkent**  
T +99-87-1238-9438  
uzb@hikvision.ru

**Hikvision Hong Kong**  
T +852-2151-1761  
info.hk@hikvision.com

**Hikvision Russia**  
T +7-495-669-67-99  
saleru@hikvision.com

**Hikvision Korea**  
T +82-(0)31-731-8817  
sales.korea@hikvision.com

**Hikvision Poland**  
T +48-22-460-01-50  
info.pl@hikvision.com

**Hikvision Indonesia**  
T +62-21-2933759  
Sales.Indonesia@hikvision.com

**Hikvision Colombia**  
sales.colombia@hikvision.com